

# 2. BLECHE & STAHLPROFILE

## 2.3 Kanteile

### Kanteile

Die Kanteile laut Abbildung können kurzfristig in einer Vielzahl verschiedener Farben und in Längen von 3,0 Meter gefertigt werden.

Genauso ist es aber möglich Kanteile laut Ihren Angaben anzufertigen. Skizze erforderlich!

#### Verfügbare Oberflächen aus Stahlblech:

- Glatt 25 µm
- Glatt 55 µm (Granite® HDX)
- Matt 35 µm
- Matt 50 µm (Granite® Storm)
- Holzdekor Eiche 25 µm
- Verzinkt

#### Verfügbare Oberflächen aus Alublech:

- Matt 25 µm
- Glatt 25 µm beidseitig

#### Verfügbare Lochbleche (Rv5-8 / Rv3-7,5) aus Stahlblech:

- Glatt 25 µm

### BEISPIELE:

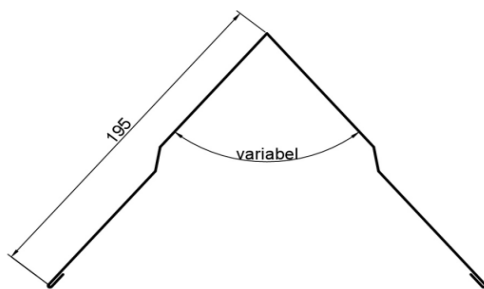

1. First L41

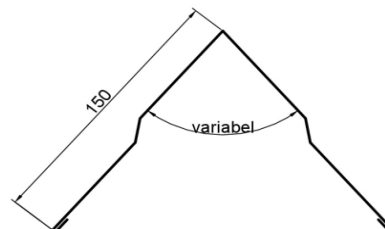

2. First M33

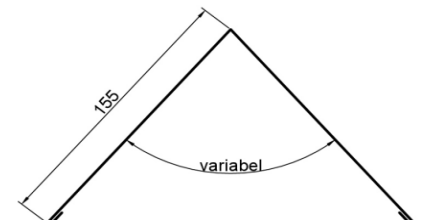

3. First S33

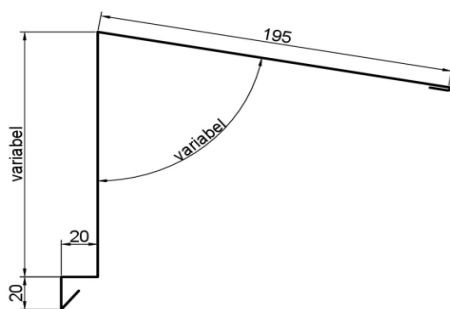

4. Ortgang SW oben L

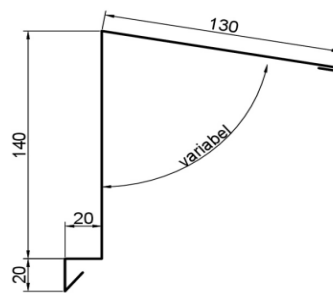

5. Pultabschluss 33

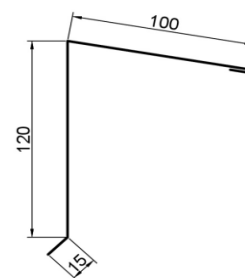

6. Pultabschluss 25

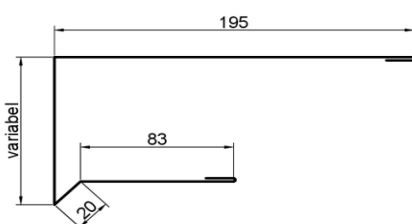

7. Ortgang SW oben U

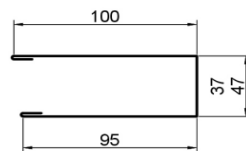

8. Pultabschluss U für Trapez

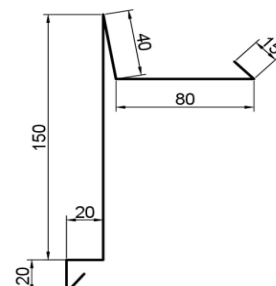

11. Ortgang Standard 33

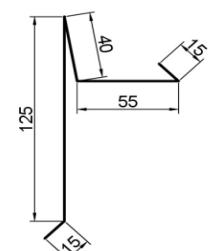

12. Ortgang Standard 25

# 2. BLECHE & STAHLPROFILE

## 2.3 Kanteile



### Kanteile

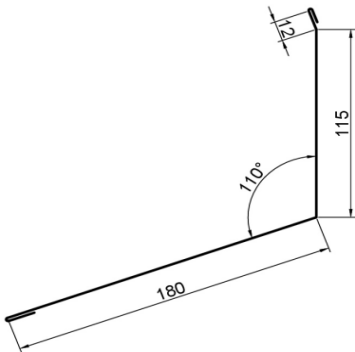

9. Wandanschluss Aufblech 33

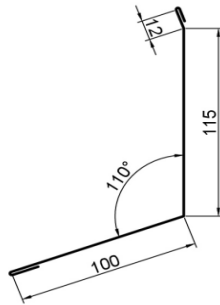

10. Wandanschluss Aufblech 25

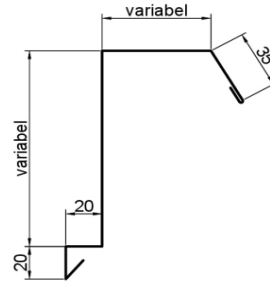

13. Ortgang Aufblech V seitlich

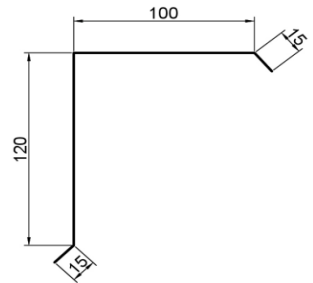

14. Ortgang Aufblech 25 seitlich

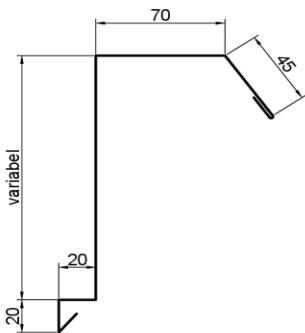

15. Ortgang SW seitlich L

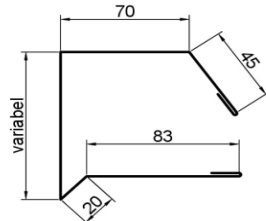

16. Ortgang SW seitlich U

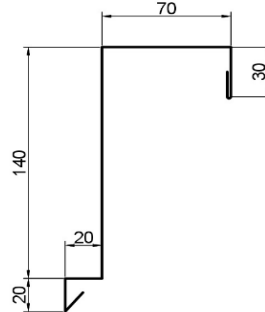

17. Ortgang Paneeldach 30

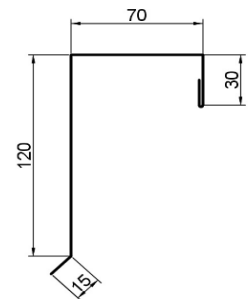

18. Ortgang Paneeldach 25

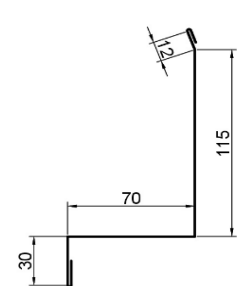

19. Wandanschluss Paneeldach seitlich 25

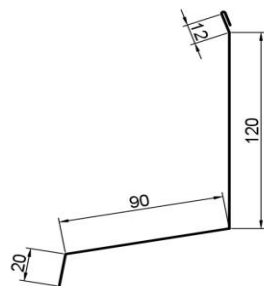

20. Wandanschluss Aufblech seitlich

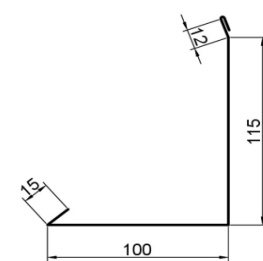

21. Wandanschluss seitlich

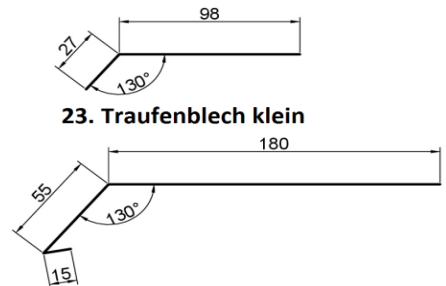

22. Traufenblech Standard

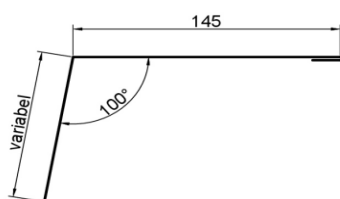

24. Traufenblech SW

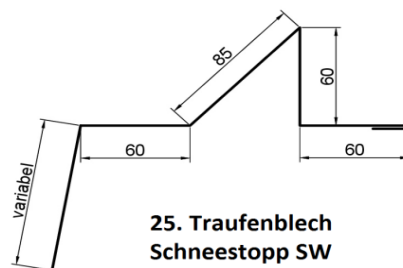

25. Traufenblech Schneestopp SW

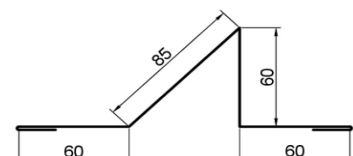

26. Schneestopper mitte

# 2. BLECHE & STAHLPROFILE

## 2.3 Kantenteile



### Kantenteile

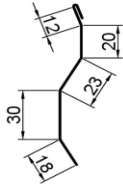

**27. Putzleiste Standard**

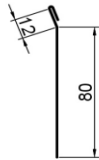

**28. Putzleiste gerade**

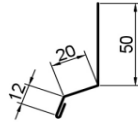

**29. Tropfkante Form A**

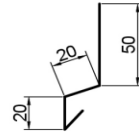

**30. Tropfkante Form B**

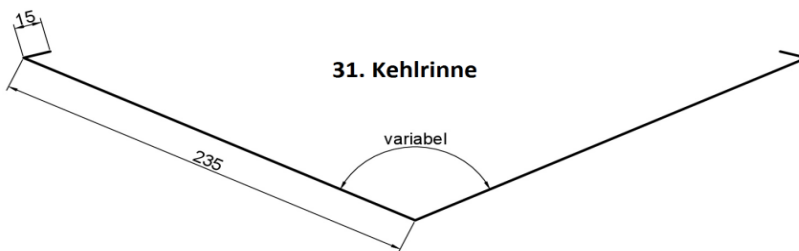

**31. Kehlrinne**

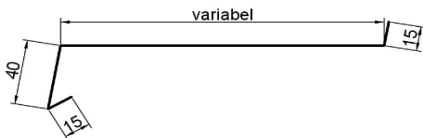

**32. Fensterbank**

#### **32. Fensterbank - Endstücke aus Kunststoff**

Farben: Ral-1002 Ral-3011 Ral-6005 Ral-9005  
Ral-3009 Ral-5010 Ral-8017 Ral-9010

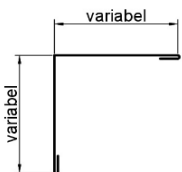

**33. Außenwinkel**

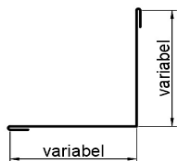

**34. Innenwinkel**

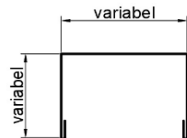

**35. U Abdeckprofil**

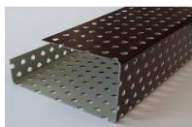

#### **Paneeldach - Distanzlüftungsprofil**

36. Distanzlüftungsprofil PD 25 (15/60/23/40)

37. Distanzlüftungsprofil PD 32 (15/60/30/40)

38. Distanzlüftungsprofil PD 38 (15/60/36/40)

### Firstabdeckungen

#### FIRSTABDECKUNG RUND

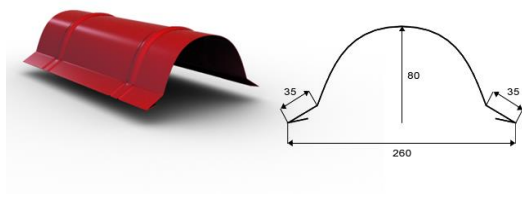

Firstabdeckung RUND ist ausschließlich in 2,0 Meter Länge lieferbar!